

Varenummer: 40550300241225
 Beskrivelse: Tandhjulsgear S301P-2,4-P71B5

Mål

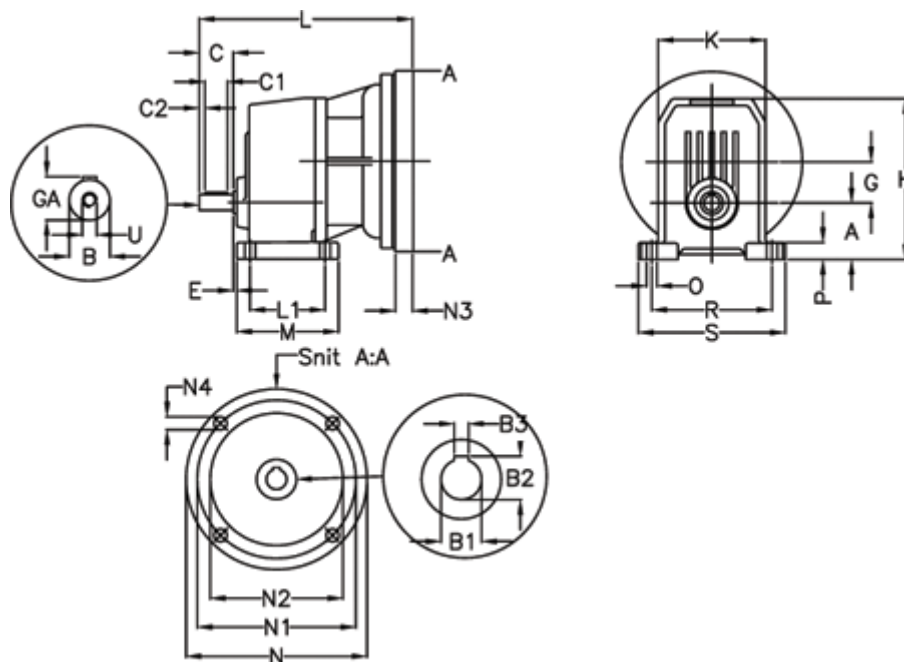

A = 60	E = 20.5	M = 125.0	R = 160
B = 24	F = 8x7x40	N = 160	S = 190
B1 = 14	G = 51.8	N1 = 130	U = M8
B2 = 16.3	GA = 27.0	N2 = 110	
B3 = 5	H = 183.0	N3 = -	
C = 50	K = 130	N4 = M8x16	
C1 = 40	L = 232	O = 11	
C2 = 5	L1 = 90.0	P = 20.0	